

Report Number: QIP-ASI100000

Audit Date : 15 Aug., 2018

This report is issued by Focus Technology Co., Ltd. (Made-in-China.com) and the supervising inspectorate (SGS-CSTC Standards Technical Services Co., Ltd. ) to confirm that:

Company Name : ABC Technical Services Co., Ltd.
ABC 技术服务有限公司
Showroom : <http://abc.en.made-in-china.com>
Address : Ruihua Building, No.315 Zhongshan South Road, Nanjing City.
Product : Lamps

has been on site audited for the Following Scope of Activity

1. General Information
2. Foreign Trade Capacity
3. Product Research & Development Capacity
4. Management System and Product Certification
5. Production Capacity & Quality Control
6. Financial Position
7. Working Environment
8. Energy Saving and Emission Reduction
9. Industry Information
10. Photos



General Comments:

ABC Technical Services Co., Ltd. is a manufacturer with 900 employees; it was established in 1991, located in Ruihua Building, No.315 Zhongshan South Road, Nanjing City. The workshops occupy an area of more than 20,000 square meters, and the annual production output was 10 million lamps in last year. ABC company has its own brand "ABC". They have passed ISO9001:2008 certification in 2009, and obtained CE certificates for lamp. ABC company has successful foreign trading experience in Europe, North America and Asia, their foreign trade revenue was around USD1.275 million in year 2009.

Sign for and on behalf of

SGS-CSTC Standards Technical Services Co., Ltd. 



This document is issued by the Company under its General Conditions of Service accessible at <http://www.sgs.com/en/Terms-and-Conditions.aspx> Attention is drawn to the limitation of liability, indemnification and jurisdiction issues defined therein. Any holder of this document is advised that information contained hereon is solely limited to visual examination of the safely and readily accessible portions of the consignment and reflects the Company's findings at the time of its intervention only and within the limits of Client's instructions, if any. The Company's sole responsibility is to its Client and this document does not exonerate parties to a transaction from exercising all their rights and obligations under the transaction documents. Any unauthorized alteration, forgery or falsification of the content or appearance of this document is unlawful and offenders may be prosecuted to the fullest extent of the law.

Attention: To check the authenticity of testing /inspection report & certificate, please contact us at telephone: (86-755) 8307 1443, or email: CN.Doccheck@sgs.com

Page No.: 1 of 26



SUPPLIER ASSESSMENT REPORT

Audited Company			
Audited Site:			
Consigner of Assessment	Made-in-China.com		
Audit Type	<input checked="" type="checkbox"/> Initial Audit <input type="checkbox"/> Re-audit		
Audit Date	15 Aug., 2018	Verify Report	www.sgs.com
Auditor		Reviewed by	

CONTENTS

- Part A: General Information**
 - Section 1: Company Overview
 - Section 2: Human Resources
- Part B: Foreign Trade Capacity**
 - Section 1: Export Overall Situation
 - Section 2: Export Business Capacity
 - Section 3: Supplier Management
 - Section 4: After-sales Service Capacity
- Part C: Product Research & Development Capacity**
 - Section 1: Product Research & Development Capacity
- Part D: Management System and Product Certification**
 - Section 1: Management System(s) and Product Certification
- Part E: Production Capacity & Quality Control**
 - Section 1: Production Capacity Section
 - Section 2: Production Process Control
- Part F: Financial Position**
 - Section 1: Financial Data
 - Section 2: Key Performance Indications
 - Section 3: Banking
 - Section 4: Product Insurance
- Part G: Working Environment**
 - Section 1: Working Environment
- Part H: Energy Saving and Emission Reduction**
 - Section 1: Environmental Management
 - Section 2: Water, Gas and Noise Control
- Part I: Industry Information**
 - Section 1: Industry Information
- Part J: Photos**
 - Section 1: Photos of Documents
 - Section 2: Photos of Company



This document is issued by the Company under its General Conditions of Service accessible at <http://www.sgs.com/en/Terms-and-Conditions.aspx>. Attention is drawn to the limitation of liability, indemnification and jurisdiction issues defined therein. Any holder of this document is advised that information contained hereon is solely limited to visual examination of the safely and readily accessible portions of the consignment and reflects the Company's findings at the time of its intervention only and within the limits of Client's instructions, if any. The Company's sole responsibility is to its Client and this document does not exonerate parties to a transaction from exercising all their rights and obligations under the transaction documents. Any unauthorized alteration, forgery or falsification of the content or appearance of this document is unlawful and offenders may be prosecuted to the fullest extent of the law.

Attention: To check the authenticity of testing / inspection report & certificate, please contact us at telephone: (86-755) 8307 1443, or email: CN.Doccheck@sgs.com

Page No.: 2 of 26



Part A: General Information

Section 1: Company Overview

1.1 Legal Validity			
Does the company have a valid business license?	<input checked="" type="checkbox"/> Yes	<input type="checkbox"/> No	<input type="checkbox"/> Others
Year of established		Registration Number	
Registered address		Valid Date	
Actual address			
Does the company in abnormal operation status list of industrial and commercial bureau?			
Registered capital			
Name of legal representative			
Business scope			
1.2 Basic Information			
Contact person			
Phone number		Fax number	
URL/Web address			
Company type	<input type="checkbox"/> Manufacturer	<input type="checkbox"/> Trading Company	
	<input type="checkbox"/> Combined	<input type="checkbox"/> Group Corporation	
Type of ownership	<input type="checkbox"/> Limited Company	<input type="checkbox"/> Public Company	<input type="checkbox"/> Foreign joint venture
	<input type="checkbox"/> State-Owned	<input type="checkbox"/> Private Owner	<input type="checkbox"/> Wholly foreign-owned enterprises
Associated company	<ul style="list-style-type: none"> ■ Audited company: ABC Technical Services Co., Ltd. ■ Associated company: CDE Technical Services Co., Ltd. ■ The relationship of two companies: <ul style="list-style-type: none"> <input checked="" type="checkbox"/> The two companies have same legal representative <input type="checkbox"/> Legal representative of two companies are immediate family or couple <input type="checkbox"/> One company has X% shares of another company <input type="checkbox"/> The two companies have same shareholders <input type="checkbox"/> Shareholders of two companies are immediate family or couple <input type="checkbox"/> Shareholders have X% shares in audited company and X% shares in associated company 		
Products manufactured / sold scope			
1.3 Company Building Information			
According to:			
<input type="checkbox"/> Land certificate	<input type="checkbox"/> Real estate certificate		
<input type="checkbox"/> Lease agreement	<input type="checkbox"/> Observation Estimated on site		
The company area	square meters		
The land occupies	square meters.		
The offices occupy	square meters.		
The workshops occupy	square meters.		



This document is issued by the Company under its General Conditions of Service accessible at <http://www.sgs.com/en/Terms-and-Conditions.aspx> Attention is drawn to the limitation of liability, indemnification and jurisdiction issues defined therein. Any holder of this document is advised that information contained hereon is solely limited to visual examination of the safely and readily accessible portions of the consignment and reflects the Company's findings at the time of its intervention only and within the limits of Client's instructions, if any. The Company's sole responsibility is to its Client and this document does not exonerate parties to a transaction from exercising all their rights and obligations under the transaction documents. Any unauthorized alteration, forgery or falsification of the content or appearance of this document is unlawful and offenders may be prosecuted to the fullest extent of the law.

Attention: To check the authenticity of testing / inspection report & certificate, please contact us at telephone: (86-755) 8307 1443, or email: CN.Doccheck@sgs.com

Page No.: 3 of 26



Section 2: Human Resources

2.1 Company Chart

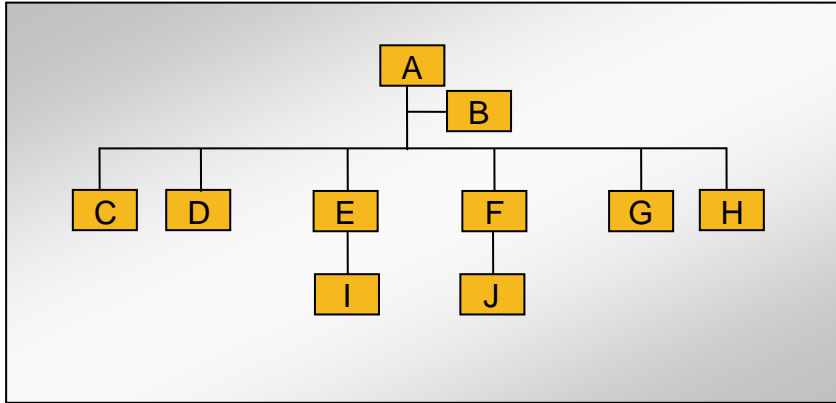

2.2 Explanation of Code and Employee Details

Code	Department	Number of employees
Number in total:		

2.3 Key Staff

Title	Full name	Education	Working experience for this trade / total experience

Remark:



This document is issued by the Company under its General Conditions of Service accessible at <http://www.sgs.com/en/Terms-and-Conditions.aspx>. Attention is drawn to the limitation of liability, indemnification and jurisdiction issues defined therein. Any holder of this document is advised that information contained hereon is solely limited to visual examination of the safely and readily accessible portions of the consignment and reflects the Company's findings at the time of its intervention only and within the limits of Client's instructions, if any. The Company's sole responsibility is to its Client and this document does not exonerate parties to a transaction from exercising all their rights and obligations under the transaction documents. Any unauthorized alteration, forgery or falsification of the content or appearance of this document is unlawful and offenders may be prosecuted to the fullest extent of the law.

Attention: To check the authenticity of testing / inspection report & certificate, please contact us at telephone: (86-755) 8307 1443, or email: CN.Doccheck@sgs.com **Page No.: 4 of 26**



Part B: Foreign Trade Capacity

Section 1: Export Overall Situation

1.1 Export Overall Situation	
Does the company have a valid Import and Export license?	<input type="checkbox"/> Yes <input type="checkbox"/> No
The import and export enterprise code.	
The number of foreign trading staff with relevant trading experience.	<input type="checkbox"/> within 1 year staff <input type="checkbox"/> 1-5 years staff <input type="checkbox"/> 6-10 years staff <input type="checkbox"/> over 10 years staff Total staff
The language freely used by foreign trade staff	<input type="checkbox"/> English <input type="checkbox"/> others
Annual revenue of previous year	
Annual export revenue of previous year	
Estimated export revenue for this year.	
Overseas agent / branch	<input type="checkbox"/> Yes <input type="checkbox"/> No
Nearest port	
Acceptable quotation terms	<input type="checkbox"/> FOB <input type="checkbox"/> CIF <input type="checkbox"/> CFR
Acceptable payment terms	<input type="checkbox"/> LC <input type="checkbox"/> T/T <input type="checkbox"/> D/P <input type="checkbox"/> PayPal <input type="checkbox"/> Western Union <input type="checkbox"/> Small-amount payment
Average lead time (Peak Season)	<input type="checkbox"/> within 15 workday <input type="checkbox"/> one month <input type="checkbox"/> 2-3 months <input type="checkbox"/> 4-6 months <input type="checkbox"/> 6-12 months <input type="checkbox"/> more time
Average lead time (Off Season)	<input type="checkbox"/> within 15 workday <input type="checkbox"/> one month <input type="checkbox"/> 2-3 months <input type="checkbox"/> 4-6 months <input type="checkbox"/> 6-12 months <input type="checkbox"/> more time

Section 2: Export Business Capacity

2.1 Market Distribution (please list top three areas)		
Market	Main Product	Main client
<input type="checkbox"/> North America		
<input type="checkbox"/> South America		
<input type="checkbox"/> Europe		
<input type="checkbox"/> Southeast Asia/ Mideast		
<input type="checkbox"/> Africa		
<input type="checkbox"/> East Asia (Japan/ South Korea)		
<input type="checkbox"/> Australia		
<input type="checkbox"/> Domestic		
<input type="checkbox"/> Others		



This document is issued by the Company under its General Conditions of Service accessible at <http://www.sgs.com/en/Terms-and-Conditions.aspx>. Attention is drawn to the limitation of liability, indemnification and jurisdiction issues defined therein. Any holder of this document is advised that information contained hereon is solely limited to visual examination of the safely and readily accessible portions of the consignment and reflects the Company's findings at the time of its intervention only and within the limits of Client's instructions, if any. The Company's sole responsibility is to its Client and this document does not exonerate parties to a transaction from exercising all their rights and obligations under the transaction documents. Any unauthorized alteration, forgery or falsification of the content or appearance of this document is unlawful and offenders may be prosecuted to the fullest extent of the law.

Attention: To check the authenticity of testing / inspection report & certificate, please contact us at telephone: (86-755) 8307 1443, or email: CN.Doccheck@sgs.com



Section 3: Supplier Management

3.1 Supplier Management		
Item	Content	Observations /Comments
1	Does the company establish and implement an effective suppliers' assessment procedure?	<input type="checkbox"/> Have the written procedures and followed records <input type="checkbox"/> Have the written procedures but no records <input type="checkbox"/> Have relevant records without written procedure <input type="checkbox"/> No written procedures or followed records
2	Does the company have an updated list of approved suppliers?	<input type="checkbox"/> The approved suppliers list was updated in _____ <input type="checkbox"/> Have the written suppliers without approved signature or date. <input type="checkbox"/> Provided some suppliers names <input type="checkbox"/> No approved suppliers list

Section 4: After-sales Service Capacity

4.1 After-sales Service Capacity		
Item	Content	Observations /Comments
1	Is there a procedure to conduct random product inspection after final packaging in place?	<input type="checkbox"/> Have clear standards and written inspection records <input type="checkbox"/> No written standards but had inspection reports <input type="checkbox"/> Have the procedures but no inspection records <input type="checkbox"/> It's not necessary to carry out the inspection
2	Is there a clear procedure for handling customer complaints?	<input type="checkbox"/> Has the clear procedure and followed records <input type="checkbox"/> Has the procedure but no written records. <input type="checkbox"/> No written procedures or records.
3	Can the finished/packaged product be traced by lot identification to the appropriate raw materials test reports?	<input type="checkbox"/> Have the procedures to trace the raw materials. <input type="checkbox"/> Can trace main materials <input type="checkbox"/> Can trace production date. <input type="checkbox"/> Can't trace products
4	Are corrective & preventive actions mechanism established and implemented effectively (including the suppliers/ sub-contractors control, incoming inspection, process control, final inspection and customer complaint)?	<input type="checkbox"/> Has the clear procedure and followed records <input type="checkbox"/> Has the procedure but no written records. <input type="checkbox"/> No written procedures or records.



This document is issued by the Company under its General Conditions of Service accessible at <http://www.sgs.com/en/Terms-and-Conditions.aspx> Attention is drawn to the limitation of liability, indemnification and jurisdiction issues defined therein. Any holder of this document is advised that information contained hereon is solely limited to visual examination of the safely and readily accessible portions of the consignment and reflects the Company's findings at the time of its intervention only and within the limits of Client's instructions, if any. The Company's sole responsibility is to its Client and this document does not exonerate parties to a transaction from exercising all their rights and obligations under the transaction documents. Any unauthorized alteration, forgery or falsification of the content or appearance of this document is unlawful and offenders may be prosecuted to the fullest extent of the law.

Attention: To check the authenticity of testing /inspection report & certificate, please contact us at telephone: (86-755) 8307 1443, or email: CN.Doccheck@sgs.com **Page No.: 6 of 26**



Part C: Product Research & Development Capacity

1.1 Product Research & Development Capacity	
The amount of R&D and relevant working experience.	<input type="checkbox"/> within 1 year staff <input type="checkbox"/> 1-5 years staff <input type="checkbox"/> 6-10 years staff <input type="checkbox"/> over 10 years staff Total engineers
What is the main job responsibility for R&D engineers?	
Is there any relevant design input, output, review, verification and validation documentation available for auditor to review?	
Is there any special software or instrument used by the R&D staffs during the design process of new products? If yes, please list the main software or instrument.	
Does the company have an effective design change control procedure in place?	
Please list the patent certificates and qualification license.	

Sample



This document is issued by the Company under its General Conditions of Service accessible at <http://www.sgs.com/en/Terms-and-Conditions.aspx> Attention is drawn to the limitation of liability, indemnification and jurisdiction issues defined therein. Any holder of this document is advised that information contained hereon is solely limited to visual examination of the safely and readily accessible portions of the consignment and reflects the Company's findings at the time of its intervention only and within the limits of Client's instructions, if any. The Company's sole responsibility is to its Client and this document does not exonerate parties to a transaction from exercising all their rights and obligations under the transaction documents. Any unauthorized alteration, forgery or falsification of the content or appearance of this document is unlawful and offenders may be prosecuted to the fullest extent of the law.

Attention: To check the authenticity of testing / inspection report & certificate, please contact us at telephone: (86-755) 8307 1443, or email: CN.Doccheck@sgs.com



Part D: Management System and Product Certification

1.1 Management System and Product Certification	
Management system certification	<input type="checkbox"/> ISO9001:2008 certificate <input type="checkbox"/> ISO14001:2004 certificate <input type="checkbox"/> OHSAS18001:2007 certificate <input type="checkbox"/> TS16949 <input type="checkbox"/> SA8000 <input type="checkbox"/> Others <input type="checkbox"/> NIL
Product certification	<input type="checkbox"/> CE <input type="checkbox"/> UL <input type="checkbox"/> CCC <input type="checkbox"/> RoHs <input type="checkbox"/> FCC <input type="checkbox"/> Others <input type="checkbox"/> NIL
Test reports for raw materials	<input type="checkbox"/> RoHS <input type="checkbox"/> Reach <input type="checkbox"/> Others <input type="checkbox"/> NIL



This document is issued by the Company under its General Conditions of Service accessible at <http://www.sgs.com/en/Terms-and-Conditions.aspx>. Attention is drawn to the limitation of liability, indemnification and jurisdiction issues defined therein. Any holder of this document is advised that information contained hereon is solely limited to visual examination of the safely and readily accessible portions of the consignment and reflects the Company's findings at the time of its intervention only and within the limits of Client's instructions, if any. The Company's sole responsibility is to its Client and this document does not exonerate parties to a transaction from exercising all their rights and obligations under the transaction documents. Any unauthorized alteration, forgery or falsification of the content or appearance of this document is unlawful and offenders may be prosecuted to the fullest extent of the law.

Attention: To check the authenticity of testing / inspection report & certificate, please contact us at telephone: (86-755) 8307 1443, or email: CN.Doccheck@sgs.com





Part E: Production Capacity & Quality Control

Section 1: Production Capacity

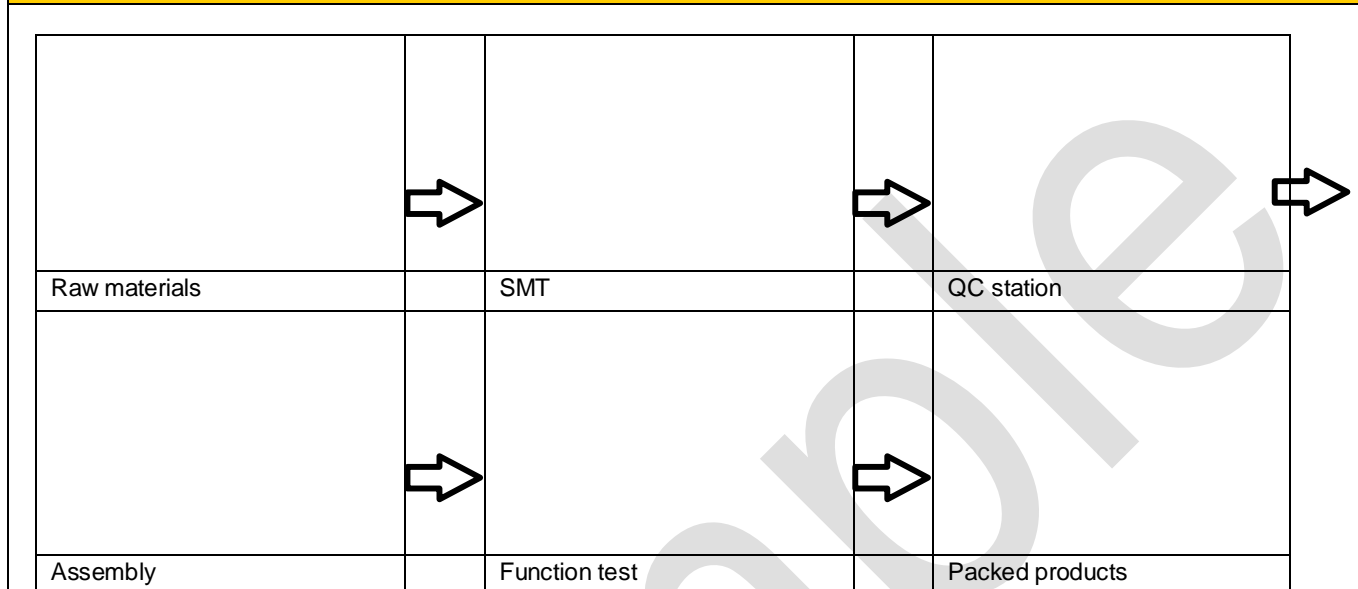
1.1 Production Workflow Chart



1.2 Products Situation (Top three Product Categories)

Product	Price range	Min. order quantity	Top monthly output	Average monthly output	Total in 2013
 Fitting					
 Solar water heater					

1.3 Main Facilities

Picture	Facility name	Brand or Country/Region of origin	Target Value/machine*day	Quantity
				



This document is issued by the Company under its General Conditions of Service accessible at <http://www.sgs.com/en/Terms-and-Conditions.aspx> Attention is drawn to the limitation of liability, indemnification and jurisdiction issues defined therein. Any holder of this document is advised that information contained hereon is solely limited to visual examination of the safely and readily accessible portions of the consignment and reflects the Company's findings at the time of its intervention only and within the limits of Client's instructions, if any. The Company's sole responsibility is to its Client and this document does not exonerate parties to a transaction from exercising all their rights and obligations under the transaction documents. Any unauthorized alteration, forgery or falsification of the content or appearance of this document is unlawful and offenders may be prosecuted to the fullest extent of the law.

Attention: To check the authenticity of testing /inspection report & certificate, please contact us at telephone: (86-755) 8307 1443, or email: CN.Doccheck@sgs.com **Page No.: 9 of 26**



Section 2: Production Process Control

2.1 Production Process Control		
Item	Content	Observations /Comments
1	Product R&D capacity	<input type="checkbox"/> Own brand <input type="checkbox"/> ODM <input type="checkbox"/> OEM
2	Are the environmental conditions, such as tidiness and cleanliness being controlled and suitable for the operation performed?	<input type="checkbox"/> Very tidy <input type="checkbox"/> Normal <input type="checkbox"/> Need to improve <input type="checkbox"/> Very poor
3	Are the necessary items /documents provided at appropriate location and under control?	<input type="checkbox"/> Work Instructions /procedures <input type="checkbox"/> Workmanship standard /acceptance <input type="checkbox"/> Golden sample /Approval sample <input type="checkbox"/> Product picture <input type="checkbox"/> Verbal by workshop director
4	Are written instructions available for incoming material inspections /testing? Is the relevant record maintained?	<input type="checkbox"/> Has instructions and uniformly followed <input type="checkbox"/> Has instruction but no written records <input type="checkbox"/> Materials checked by storage staff
5	Are written inspections /testing instructions available for finished products? Is the relevant record maintained?	<input type="checkbox"/> Have instructions and uniformly followed <input type="checkbox"/> Have instruction but no written records <input type="checkbox"/> Finished product checked by packing staff
6	What type of inspection is used for finished products?	<input type="checkbox"/> Random inspection <input type="checkbox"/> Visual inspection <input type="checkbox"/> Function inspection <input type="checkbox"/> 100% inspection <input type="checkbox"/> Visual inspection <input type="checkbox"/> Function inspection
7	Are non-conforming units clearly marked/ segregated to prevent accidental dispatch?	<input type="checkbox"/> Marked and segregated <input type="checkbox"/> Segregated but not marked clearly <input type="checkbox"/> Not found on site
8	How are the non-conforming units handled?	<input type="checkbox"/> Repaired and re-inspection <input type="checkbox"/> Picked out <input type="checkbox"/> Used under control <input type="checkbox"/> Others



This document is issued by the Company under its General Conditions of Service accessible at <http://www.sgs.com/en/Terms-and-Conditions.aspx> Attention is drawn to the limitation of liability, indemnification and jurisdiction issues defined therein. Any holder of this document is advised that information contained hereon is solely limited to visual examination of the safely and readily accessible portions of the consignment and reflects the Company's findings at the time of its intervention only and within the limits of Client's instructions, if any. The Company's sole responsibility is to its Client and this document does not exonerate parties to a transaction from exercising all their rights and obligations under the transaction documents. Any unauthorized alteration, forgery or falsification of the content or appearance of this document is unlawful and offenders may be prosecuted to the fullest extent of the law.

Attention: To check the authenticity of testing /inspection report & certificate, please contact us at telephone: (86-755) 8307 1443, or email: CN.Doccheck@sgs.com **Page No.: 10 of 26**

Part F: Financial Position

Section 1: Financial Data

1.1 Income Statement				
Item	Content	2013	2012	2011
1	Operating revenue			
2	Operating cost			
3	Gross profit			
4	Operating profit			
1.2 Balance Sheet				
Item	Content	2013	2012	2011
1	Cash and cash equivalents			
2	Total current assets			
3	Total current liabilities			
4	Total assets			
1.3 Cash Flow From Operating Activities				
Item	Content	2013	2012	2011
1	Cash received from sales of goods or rendering of services			
2	Sub-total of cash inflows			
3	Sub-total of cash outflows			

Remark: 1、 All monetary amounts quoted in this part are shown in RMB, unless otherwise stated.
2、 all financial data was from the audited company's financial reports reviewed by ****accounting firm.



This document is issued by the Company under its General Conditions of Service accessible at <http://www.sgs.com/en/Terms-and-Conditions.aspx>. Attention is drawn to the limitation of liability, indemnification and jurisdiction issues defined therein. Any holder of this document is advised that information contained hereon is solely limited to visual examination of the safely and readily accessible portions of the consignment and reflects the Company's findings at the time of its intervention only and within the limits of Client's instructions, if any. The Company's sole responsibility is to its Client and this document does not exonerate parties to a transaction from exercising all their rights and obligations under the transaction documents. Any unauthorized alteration, forgery or falsification of the content or appearance of this document is unlawful and offenders may be prosecuted to the fullest extent of the law.

Attention: To check the authenticity of testing / inspection report & certificate, please contact us at telephone: (86-755) 8307 1443, or email: CN.Doccheck@sgs.com

Page No.: 11 of 26



Section 2: Key Performance Indication

2.1 Key Performance Indication				
Item	Content	2013	2012	2011
1	Operating revenues year-on-year rise (OR in this year- OR in last year) / (OR in last year)			
2	Gross Margin Gross profit/ Operating revenues			
3	Current ratio Current assets / Current liabilities			

Section 3: Banking

3.1 Banking		
Item	Content	Comments
1	Opening bank	
2	A/C No.:	
3	The credit level evaluated by bank	

Section 4: Product Insurance

4.1 Product Insurance				
Certification	Insurer	Number	Product	Expiry date



This document is issued by the Company under its General Conditions of Service accessible at <http://www.sgs.com/en/Terms-and-Conditions.aspx> Attention is drawn to the limitation of liability, indemnification and jurisdiction issues defined therein. Any holder of this document is advised that information contained hereon is solely limited to visual examination of the safely and readily accessible portions of the consignment and reflects the Company's findings at the time of its intervention only and within the limits of Client's instructions, if any. The Company's sole responsibility is to its Client and this document does not exonerate parties to a transaction from exercising all their rights and obligations under the transaction documents. Any unauthorized alteration, forgery or falsification of the content or appearance of this document is unlawful and offenders may be prosecuted to the fullest extent of the law.

Attention: To check the authenticity of testing /inspection report & certificate, please contact us at telephone: (86-755) 8307 1443, or email: CN.Doccheck@sgs.com **Page No.: 12 of 26**



Part G: Working Environment

Section 1: Working Environment

1.1 Welfare Benefits		
Item	Content	Observations /Comments
1	Does the company have effective procedures to verify the age of staff at the time of recruitment?	<input type="checkbox"/> Has written procedure and keeps adequate age documents of workers <input type="checkbox"/> Has written procedure but doesn't follow records <input type="checkbox"/> Hasn't written procedure or follows records
2	Do all workers sign employment contracts with the factory?	<input type="checkbox"/> All workers sign employment contracts <input type="checkbox"/> Some workers sign employment contracts <input type="checkbox"/> Only management staff sign employment contracts <input type="checkbox"/> No staff sign employment contracts
3	Is statutory contribution required for all employees' social insurance (e.g. health insurance, unemployment insurance, accident insurance etc.) paid for by the enterprise?	<input type="checkbox"/> All workers have social insurance. <input type="checkbox"/> Some workers have social insurance <input type="checkbox"/> Only management staffs have social insurance <input type="checkbox"/> No staff have social insurance
4	Does the company have a clear and effective policy on working hours, rest and vacations? If does, please list it.	<input type="checkbox"/> All staffs work kept to the policy <input type="checkbox"/> Most of the time it keeps to the policy except midseason. <input type="checkbox"/> Usually needs overtime. <input type="checkbox"/> No relevant records for working hours Describe the working hours:
5	Does the company pay extra remunerations for all overtime work?	<input type="checkbox"/> For all overtime work. <input type="checkbox"/> For official holidays <input type="checkbox"/> For official holidays except weekend. <input type="checkbox"/> No extra remunerations for overtime.
6	Does the company have dormitories for staff? If yes, please describe the condition.	<input type="checkbox"/> Provide dormitories for all staff <input type="checkbox"/> Provide dormitories for workers <input type="checkbox"/> Provide dormitories for management staff <input type="checkbox"/> No dormitories were provided. Describe the condition:
1.2 Labor Protection		
Item	Content	Observations /Comments
1	Are there uniforms for all staff in company?	<input type="checkbox"/> Yes <input type="checkbox"/> No <input type="checkbox"/> Other
2	Is the emergency medical supplies enough and easily used in workshop?	<input type="checkbox"/> Yes <input type="checkbox"/> No <input type="checkbox"/> Other
3	Does the company arrange health and safety training for new workers?	<input type="checkbox"/> Yes <input type="checkbox"/> No <input type="checkbox"/> Other
4	Do the workers have the appropriate protective equipment during operation in workshop? Such as gloves, masks.	<input type="checkbox"/> Yes <input type="checkbox"/> No <input type="checkbox"/> Other
5	Is there training needed and carried out for fire protection?	<input type="checkbox"/> Yes <input type="checkbox"/> No <input type="checkbox"/> Other



This document is issued by the Company under its General Conditions of Service accessible at <http://www.sgs.com/en/Terms-and-Conditions.aspx>. Attention is drawn to the limitation of liability, indemnification and jurisdiction issues defined therein. Any holder of this document is advised that information contained hereon is solely limited to visual examination of the safely and readily accessible portions of the consignment and reflects the Company's findings at the time of its intervention only and within the limits of Client's instructions, if any. The Company's sole responsibility is to its Client and this document does not exonerate parties to a transaction from exercising all their rights and obligations under the transaction documents. Any unauthorized alteration, forgery or falsification of the content or appearance of this document is unlawful and offenders may be prosecuted to the fullest extent of the law.

Attention: To check the authenticity of testing /inspection report & certificate, please contact us at telephone: (86-755) 8307 1443, or email: CN.Doccheck@sgs.com

Page No.: 13 of 26



Part H: Energy Saving and Emission Reduction

Section 1: Environmental Management

1.1 Environmental Management		
Item	Content	Observations /Comments
1	Environmental Management System	<input type="checkbox"/> ISO 14001 Certificate <input type="checkbox"/> Cleaner production management <input type="checkbox"/> NIL
2	Environmental Impact Assessment	<input type="checkbox"/> The Report of Environmental impact assessment is approved by EPA Nanjing city in 2011. <input type="checkbox"/> NIL
3	Check and Acceptance of Completed Constructive Projects	<input type="checkbox"/> The Report Completed Constructive Projects Inspection and Acceptance is approved. <input type="checkbox"/> The company was founded in 1970 without relevant assessment report, they had a review report for environmental control in 2011. <input type="checkbox"/> NIL
4	"Three Simultaneity" for Environmental protection	<input type="checkbox"/> The Report of "Three Simultaneity" for Environmental protection Inspection and Acceptance is available. <input type="checkbox"/> The company was founded in 1970 without relevant assessment report, they had a review report for environmental control in 2011. <input type="checkbox"/> NIL

Section 2: Water, Gas and Noise Control

2.1 Water, Gas and Noise Control		
Item	Content	Observations /Comments
1	Water-intaking	<input type="checkbox"/> Water-intaking license <input type="checkbox"/> No water-intaking license <input type="checkbox"/> No water taken from natural water body
2	Waste water	<input type="checkbox"/> Water-draining license or contract <input type="checkbox"/> Having carried out waste water treatment before draining <input type="checkbox"/> Having carried out waste water monitoring and the result of which being within the standard limit <input type="checkbox"/> No detail activities were found
3	Emission to air	<input type="checkbox"/> Air pollutant emission license <input type="checkbox"/> Having carried out air pollutant emission monitoring and the result of which being within the standard limit <input type="checkbox"/> No detail activities were found to reduce emission to air
4	Classification and Recycling for solid waste	<input type="checkbox"/> Having applied trash classification recycling <input type="checkbox"/> Having special warehouse for hazardous waste <input type="checkbox"/> No detail activities were found
5	Noise	<input type="checkbox"/> The company carried out noise monitoring and the result of which being within the standard limit one time per year <input type="checkbox"/> No detail activities were found



This document is issued by the Company under its General Conditions of Service accessible at <http://www.sgs.com/en/Terms-and-Conditions.aspx>. Attention is drawn to the limitation of liability, indemnification and jurisdiction issues defined therein. Any holder of this document is advised that information contained hereon is solely limited to visual examination of the safely and readily accessible portions of the consignment and reflects the Company's findings at the time of its intervention only and within the limits of Client's instructions, if any. The Company's sole responsibility is to its Client and this document does not exonerate parties to a transaction from exercising all their rights and obligations under the transaction documents. Any unauthorized alteration, forgery or falsification of the content or appearance of this document is unlawful and offenders may be prosecuted to the fullest extent of the law.

Attention: To check the authenticity of testing /inspection report & certificate, please contact us at telephone: (86-755) 8307 1443, or email: CN.Doccheck@sgs.com **Page No.: 14 of 26**



Part I: Industry Information

Section 1: Industry Information

1.1 Furniture Industry Information		
Item	Content	Observations
1	Product style	<input type="checkbox"/> European style furniture <input type="checkbox"/> American style furniture <input type="checkbox"/> Chinese style furniture <input type="checkbox"/> Korean rural style furniture <input type="checkbox"/> Mediterranean style furniture <input type="checkbox"/> Others
2	Product materials	<input type="checkbox"/> Jade furniture <input type="checkbox"/> Solid wood furniture <input type="checkbox"/> Panel-type furniture <input type="checkbox"/> Soft furniture <input type="checkbox"/> Woven rattan furniture <input type="checkbox"/> Others
3	Used Locations	<input type="checkbox"/> Outdoor <input type="checkbox"/> Kitchen <input type="checkbox"/> Living room <input type="checkbox"/> Children room <input type="checkbox"/> Office room <input type="checkbox"/> Others
4	Product structure	<input type="checkbox"/> Assembled furniture <input type="checkbox"/> Detachable furniture <input type="checkbox"/> Folding furniture <input type="checkbox"/> Combination furniture <input type="checkbox"/> Even wall furniture <input type="checkbox"/> Hanging furniture
5	Modelling effect	<input type="checkbox"/> Ordinary furniture <input type="checkbox"/> Art furniture
6	Regulation requirement test	<input type="checkbox"/> California 65 <input type="checkbox"/> CPSIA <input type="checkbox"/> Reach <input type="checkbox"/> CARB certification <input type="checkbox"/> FACC certification <input type="checkbox"/> Others <input type="checkbox"/> Nil
7	Key Account	<input type="checkbox"/> Wal-Mart <input type="checkbox"/> Home Depot <input type="checkbox"/> Lowes <input type="checkbox"/> Target <input type="checkbox"/> Costco <input type="checkbox"/> Office Max <input type="checkbox"/> Others <input type="checkbox"/> Nil



This document is issued by the Company under its General Conditions of Service accessible at <http://www.sgs.com/en/Terms-and-Conditions.aspx>. Attention is drawn to the limitation of liability, indemnification and jurisdiction issues defined therein. Any holder of this document is advised that information contained hereon is solely limited to visual examination of the safely and readily accessible portions of the consignment and reflects the Company's findings at the time of its intervention only and within the limits of Client's instructions, if any. The Company's sole responsibility is to its Client and this document does not exonerate parties to a transaction from exercising all their rights and obligations under the transaction documents. Any unauthorized alteration, forgery or falsification of the content or appearance of this document is unlawful and offenders may be prosecuted to the fullest extent of the law.

Attention: To check the authenticity of testing / inspection report & certificate, please contact us at telephone: (86-755) 8307 1443, or email: CN.Doccheck@sgs.com



1.1 Apparel Industry Information		
Item	Content	Observations
1	Product character	<input type="checkbox"/> Woven <input type="checkbox"/> Knitting <input type="checkbox"/> Leather <input type="checkbox"/> Others
2	Product type	<input type="checkbox"/> Suits <input type="checkbox"/> Vest <input type="checkbox"/> Jeans <input type="checkbox"/> Jacket <input type="checkbox"/> Shirt <input type="checkbox"/> Padded coat <input type="checkbox"/> Down coat <input type="checkbox"/> T shirt <input type="checkbox"/> Sweater <input type="checkbox"/> Cardigan <input type="checkbox"/> Trousers <input type="checkbox"/> Underwear <input type="checkbox"/> Sportswear <input type="checkbox"/> Accessories <input type="checkbox"/> Others
3	Product type for age range	<input type="checkbox"/> Baby <input type="checkbox"/> Children <input type="checkbox"/> Junior <input type="checkbox"/> Adult <input type="checkbox"/> Old adult <input type="checkbox"/> Others
4	Product type for season	<input type="checkbox"/> Spring and Autumn <input type="checkbox"/> Summer <input type="checkbox"/> Winter
5	Product type for fiber content	<input type="checkbox"/> Cotton, <input type="checkbox"/> Linen <input type="checkbox"/> Silk <input type="checkbox"/> Wool <input type="checkbox"/> Cashmere <input type="checkbox"/> Feather&Down <input type="checkbox"/> Others
6	Product type for sexuality	<input type="checkbox"/> Man <input type="checkbox"/> Woman
7	Special processes	<input type="checkbox"/> Grey cloth garment, <input type="checkbox"/> Yarn dyeing garment <input type="checkbox"/> Embroidery garment <input type="checkbox"/> Garment dyed <input type="checkbox"/> Enzyme wash <input type="checkbox"/> Sand wash <input type="checkbox"/> Others
8	Functional apparel	<input type="checkbox"/> Moisture wicking <input type="checkbox"/> quick dry <input type="checkbox"/> Wrinkle free <input type="checkbox"/> Windproof <input type="checkbox"/> Waterproof <input type="checkbox"/> Antistatic finishing <input type="checkbox"/> Flame-retardation finishing <input type="checkbox"/> Antibacterial <input type="checkbox"/> Others
9	Green test	<input type="checkbox"/> OKO 100 certificate <input type="checkbox"/> Blue sign certificate <input type="checkbox"/> Others
10	Key Account	<input type="checkbox"/> Gap <input type="checkbox"/> Ralph Lauren <input type="checkbox"/> Hugo Boss <input type="checkbox"/> Nike <input type="checkbox"/> Calvin Klein <input type="checkbox"/> Others



This document is issued by the Company under its General Conditions of Service accessible at <http://www.sgs.com/en/Terms-and-Conditions.aspx> Attention is drawn to the limitation of liability, indemnification and jurisdiction issues defined therein. Any holder of this document is advised that information contained hereon is solely limited to visual examination of the safely and readily accessible portions of the consignment and reflects the Company's findings at the time of its intervention only and within the limits of Client's instructions, if any. The Company's sole responsibility is to its Client and this document does not exonerate parties to a transaction from exercising all their rights and obligations under the transaction documents. Any unauthorized alteration, forgery or falsification of the content or appearance of this document is unlawful and offenders may be prosecuted to the fullest extent of the law.

Attention: To check the authenticity of testing / inspection report & certificate, please contact us at telephone: (86-755) 8307 1443, or email: CN.Doccheck@sgs.com



1.1 LED Lighting Industry Information		
Item	Content	Observations
1	LED Product Type	<input type="checkbox"/> LED Display/Screen <input type="checkbox"/> House light <input type="checkbox"/> LED industry light <input type="checkbox"/> LED traffic light <input type="checkbox"/> LED public light <input type="checkbox"/> Others
2	LED chip origin(s)	<input type="checkbox"/> Europe <input type="checkbox"/> American <input type="checkbox"/> Japan <input type="checkbox"/> Korea <input type="checkbox"/> Taiwan <input type="checkbox"/> Mainland in China
3	SMT production line	<input type="checkbox"/> Import equipment <input type="checkbox"/> Domestic equipment <input type="checkbox"/> No SMT production line
4	Testing machines	<input type="checkbox"/> Automatic spectrophotometric color machine <input type="checkbox"/> Integrating sphere <input type="checkbox"/> spectrum analyzer <input type="checkbox"/> Others
5	Welding process	<input type="checkbox"/> Manual welding <input type="checkbox"/> Automatic welding
6	Safety testing reports	<input type="checkbox"/> IEC60560 <input type="checkbox"/> IEC60598 <input type="checkbox"/> IEC62031 <input type="checkbox"/> IEC61347 <input type="checkbox"/> IEC62471 <input type="checkbox"/> Nil
7	Performance testing report	<input type="checkbox"/> IEC62722 <input type="checkbox"/> IEC62384 <input type="checkbox"/> IEC62717 <input type="checkbox"/> IEC62162 <input type="checkbox"/> Nil
8	Efficiency test	<input type="checkbox"/> MEPS <input type="checkbox"/> ErP (244/2009/EC) <input type="checkbox"/> Energy Star <input type="checkbox"/> Energy label (98/11/EC) <input type="checkbox"/> CEC <input type="checkbox"/> ELI <input type="checkbox"/> Nil

1.1 Faucet Industry Information		
Item	Content	Observations
1	Product Structure	<input type="checkbox"/> Single Duplex Faucet <input type="checkbox"/> Duplex Type Single Control Faucet <input type="checkbox"/> Duplex Type Double Control Faucet <input type="checkbox"/> Triple Type Single Control Faucet <input type="checkbox"/> Triple Type Double Control Faucet <input type="checkbox"/> Others
2	Open Way	<input type="checkbox"/> Spiral Type <input type="checkbox"/> Wrench-Type <input type="checkbox"/> Up open Type <input type="checkbox"/> Push Type <input type="checkbox"/> Touch-Type <input type="checkbox"/> Induction Type <input type="checkbox"/> Others

This document is issued by the Company under its General Conditions of Service accessible at <http://www.sgs.com/en/Terms-and-Conditions.aspx> Attention is drawn to the limitation of liability, indemnification and jurisdiction issues defined therein. Any holder of this document is advised that information contained hereon is solely limited to visual examination of the safely and readily accessible portions of the consignment and reflects the Company's findings at the time of its intervention only and within the limits of Client's instructions, if any. The Company's sole responsibility is to its Client and this document does not exonerate parties to a transaction from exercising all their rights and obligations under the transaction documents. Any unauthorized alteration, forgery or falsification of the content or appearance of this document is unlawful and offenders may be prosecuted to the fullest extent of the law.

Attention: To check the authenticity of testing / inspection report & certificate, please contact us at telephone: (86-755) 8307 1443, or email: CN.Doccheck@sgs.com **Page No.: 17 of 26**





3	Function	<input type="checkbox"/> Basin Mixer <input type="checkbox"/> Shower Mixer <input type="checkbox"/> Bidet Mixer <input type="checkbox"/> Outer door Mixer	<input type="checkbox"/> Bathtub Mixer <input type="checkbox"/> Kitchen(Sink) Mixer <input type="checkbox"/> Induction Flush Valve <input type="checkbox"/> Others
4	Water Temperature	<input type="checkbox"/> Single Function Mixer <input type="checkbox"/> Thermostatic Mixer	<input type="checkbox"/> Cold and Hot Mix Faucet <input type="checkbox"/> Others
5	Installation Structure	<input type="checkbox"/> Centerset <input type="checkbox"/> Wall-mount <input type="checkbox"/> Others	<input type="checkbox"/> Widespread <input type="checkbox"/> Waterfall
6	Installation Size	<input type="checkbox"/> Three Hole 8 inches Basin Faucet <input type="checkbox"/> Double Hole 4 inches Basin Faucet	<input type="checkbox"/> Single Span Basin Faucet <input type="checkbox"/> Others
7	Surface Treatment	<input type="checkbox"/> Chrome <input type="checkbox"/> Porcelain	<input type="checkbox"/> Ti-PVD <input type="checkbox"/> Brushed Nickel <input type="checkbox"/> ORB <input type="checkbox"/> Painting <input type="checkbox"/> Others
8	Cartridge	<input type="checkbox"/> Ceramic Cartridge <input type="checkbox"/> Stainless Steel Valve <input type="checkbox"/> Quick Open Valve <input type="checkbox"/> Others	<input type="checkbox"/> Rubber Cartridge <input type="checkbox"/> Conventional Valve <input type="checkbox"/> Thermostatic Cartridge
9	Regulation requirements	USA <input type="checkbox"/> UPC (CUPC)ASME A112.18.1/CSA B125 <input type="checkbox"/> NSF(NSF61-9) <input type="checkbox"/> WaterSense Canada <input type="checkbox"/> CSA (ASME A112.18.1/CAS B125) England <input type="checkbox"/> WRAS (BS6920 And BS5412) Germany <input type="checkbox"/> DVGW (KTW W 270 Kunststoffe im Trinkwasser 、 EN 817 and EN200) <input type="checkbox"/> KTW(KTW W 270 Kunststoffe im Trinkwasser) France <input type="checkbox"/> ACS (AFNOR XP P41-250-1、 2、 3) <input type="checkbox"/> NF(EN 817 和 EN 200) Netherlands <input type="checkbox"/> KIWA(KIWA, Richtlijn Kwaliteit Materialien en Chemikalien Drinkwatervoorziening) Australia <input type="checkbox"/> WaterMark <input type="checkbox"/> Others	



This document is issued by the Company under its General Conditions of Service accessible at <http://www.sgs.com/en/Terms-and-Conditions.aspx> Attention is drawn to the limitation of liability, indemnification and jurisdiction issues defined therein. Any holder of this document is advised that information contained hereon is solely limited to visual examination of the safety and readily accessible portions of the consignment and reflects the Company's findings at the time of its intervention only and within the limits of Client's instructions, if any. The Company's sole responsibility is to its Client and this document does not exonerate parties to a transaction from exercising all their rights and obligations under the transaction documents. Any unauthorized alteration, forgery or falsification of the content or appearance of this document is unlawful and offenders may be prosecuted to the fullest extent of the law.

Attention: To check the authenticity of testing /inspection report & certificate, please contact us at telephone: (86-755) 8307 1443, or email: CN.Doccheck@sgs.com **Page No.: 18 of 26**



1.1 Storage Battery Industry Information

Item	Content	Observations
1	Product Categories	<input type="checkbox"/> Primary Battery / Dry Battery <input type="checkbox"/> Secondary Battery / Rechargeable Battery <input type="checkbox"/> Storage Battery / Lead Acid Battery <input type="checkbox"/> Photovoltaic Cell <input type="checkbox"/> Fuel Cell <input type="checkbox"/> Others
2	Product Applications	<input type="checkbox"/> Daily Life <input type="checkbox"/> Digital <input type="checkbox"/> Telecommunication <input type="checkbox"/> Traffic <input type="checkbox"/> Lighting <input type="checkbox"/> Industrial <input type="checkbox"/> Others
3	Product Styles	<input type="checkbox"/> Cylindrical <input type="checkbox"/> Prismatic <input type="checkbox"/> Pouch <input type="checkbox"/> Button <input type="checkbox"/> others
4	Nominal Voltages	<input type="checkbox"/> 1.4V <input type="checkbox"/> 1.5V <input type="checkbox"/> 2V <input type="checkbox"/> 3V <input type="checkbox"/> 3.6V <input type="checkbox"/> 4.5V <input type="checkbox"/> 6V <input type="checkbox"/> 8V <input type="checkbox"/> 9V <input type="checkbox"/> 12V <input type="checkbox"/> Others
5	Electrolytes Types	<input type="checkbox"/> Alkaline <input type="checkbox"/> Acidic <input type="checkbox"/> Organic <input type="checkbox"/> Others
6	Electrode Materials	<input type="checkbox"/> Zn-MnO ₂ <input type="checkbox"/> Li-MnO ₂ <input type="checkbox"/> Ni-Cd <input type="checkbox"/> Ni-MH <input type="checkbox"/> Li-ion <input type="checkbox"/> Li-Polymer <input type="checkbox"/> Lead-Acid <input type="checkbox"/> Others
7	Testing Reports	<input type="checkbox"/> IEC 60086 <input type="checkbox"/> IEC 62133 <input type="checkbox"/> IEC 61951 <input type="checkbox"/> IEC 61960 <input type="checkbox"/> IEC 61056 <input type="checkbox"/> IEC 60095 <input type="checkbox"/> IEC 60254 <input type="checkbox"/> IEC 60896 <input type="checkbox"/> IEC 61982 <input type="checkbox"/> UL 1642 <input type="checkbox"/> UL 2054 <input type="checkbox"/> UL 1989 <input type="checkbox"/> IEEE 1625 <input type="checkbox"/> IEEE 1725 <input type="checkbox"/> Others
8	Regulation Requirements	<input type="checkbox"/> 2006/66/EC <input type="checkbox"/> WEEE(2002/96/EC) <input type="checkbox"/> REACH <input type="checkbox"/> RoHS(2002/95/EC) <input type="checkbox"/> HMR <input type="checkbox"/> FCC <input type="checkbox"/> UN 38.3 <input type="checkbox"/> Others



This document is issued by the Company under its General Conditions of Service accessible at <http://www.sgs.com/en/Terms-and-Conditions.aspx> Attention is drawn to the limitation of liability, indemnification and jurisdiction issues defined therein. Any holder of this document is advised that information contained hereon is solely limited to visual examination of the safely and readily accessible portions of the consignment and reflects the Company's findings at the time of its intervention only and within the limits of Client's instructions, if any. The Company's sole responsibility is to its Client and this document does not exonerate parties to a transaction from exercising all their rights and obligations under the transaction documents. Any unauthorized alteration, forgery or falsification of the content or appearance of this document is unlawful and offenders may be prosecuted to the fullest extent of the law.

Attention: To check the authenticity of testing /inspection report & certificate, please contact us at telephone: (86-755) 8307 1443, or email: CN.Doccheck@sgs.com **Page No.: 19 of 26**



1.1 Sand & Stone Industry Information		
Item	Content	Observations
1	Product Property	<input type="checkbox"/> Granite <input type="checkbox"/> Sandstone, Cobble & Pebble <input type="checkbox"/> Marble <input type="checkbox"/> Artificial Stone <input type="checkbox"/> Others
2	Product Used	<input type="checkbox"/> Wall/floor Tiles <input type="checkbox"/> Construction Rubble <input type="checkbox"/> Table Surface <input type="checkbox"/> Slate <input type="checkbox"/> Carved Sculpture <input type="checkbox"/> Stair Baluster <input type="checkbox"/> Others
3	Product Function	<input type="checkbox"/> For Load Bearing <input type="checkbox"/> For Structure Maintenance <input type="checkbox"/> For Decoration <input type="checkbox"/> Others
4	Product Color	<input type="checkbox"/> Nature Single-color <input type="checkbox"/> Nature Multicolour <input type="checkbox"/> Artificial Single-color <input type="checkbox"/> Artificial Multicolour
5	Product Style	<input type="checkbox"/> Raw Stone <input type="checkbox"/> Processed Stone <input type="checkbox"/> Art Stone <input type="checkbox"/> Others
6	Testing Report	<input type="checkbox"/> Radioactivity <input type="checkbox"/> Hardness <input type="checkbox"/> Density <input type="checkbox"/> Water Absorption <input type="checkbox"/> Bending strength <input type="checkbox"/> Others <input type="checkbox"/> Nil
7	Regulation Requirements	<input type="checkbox"/> CE <input type="checkbox"/> GB6566 <input type="checkbox"/> CPD (Construction Product Directive) <input type="checkbox"/> Nil <input type="checkbox"/> Others







This document is issued by the Company under its General Conditions of Service accessible at <http://www.sgs.com/en/Terms-and-Conditions.aspx>. Attention is drawn to the limitation of liability, indemnification and jurisdiction issues defined therein. Any holder of this document is advised that information contained hereon is solely limited to visual examination of the safely and readily accessible portions of the consignment and reflects the Company's findings at the time of its intervention only and within the limits of Client's instructions, if any. The Company's sole responsibility is to its Client and this document does not exonerate parties to a transaction from exercising all their rights and obligations under the transaction documents. Any unauthorized alteration, forgery or falsification of the content or appearance of this document is unlawful and offenders may be prosecuted to the fullest extent of the law.

Attention: To check the authenticity of testing / inspection report & certificate, please contact us at telephone: (86-755) 8307 1443, or email: CN.Doccheck@sgs.com



Part J: Photos

Section 1: Photos of Documents

1.1 Photos of Documents	
Description: Business License	Description: Land Certificate
 <p>Made-in-China.com</p>	 <p>Made-in-China.com</p>
Description: Export License	Description: Custom Registration
 <p>Made-in-China.com</p>	 <p>Made-in-China.com</p>
Description: ISO9001 Certificate	Description: CE Certificate



This document is issued by the Company under its General Conditions of Service accessible at <http://www.sgs.com/en/Terms-and-Conditions.aspx>. Attention is drawn to the limitation of liability, indemnification and jurisdiction issues defined therein. Any holder of this document is advised that information contained hereon is solely limited to visual examination of the safely and readily accessible portions of the consignment and reflects the Company's findings at the time of its intervention only and within the limits of Client's instructions, if any. The Company's sole responsibility is to its Client and this document does not exonerate parties to a transaction from exercising all their rights and obligations under the transaction documents. Any unauthorized alteration, forgery or falsification of the content or appearance of this document is unlawful and offenders may be prosecuted to the fullest extent of the law.

Attention: To check the authenticity of testing / inspection report & certificate, please contact us at telephone: (86-755) 8307 1443, or email: CN.Doccheck@sgs.com

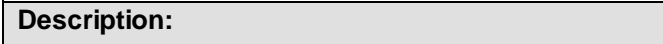

This document is issued by the Company under its General Conditions of Service accessible at <http://www.sgs.com/en/Terms-and-Conditions.aspx> Attention is drawn to the limitation of liability, indemnification and jurisdiction issues defined therein. Any holder of this document is advised that information contained hereon is solely limited to visual examination of the safely and readily accessible portions of the consignment and reflects the Company's findings at the time of its intervention only and within the limits of Client's instructions, if any. The Company's sole responsibility is to its Client and this document does not exonerate parties to a transaction from exercising all their rights and obligations under the transaction documents. Any unauthorized alteration, forgery or falsification of the content or appearance of this document is unlawful and offenders may be prosecuted to the fullest extent of the law.

Attention: To check the authenticity of testing / inspection report & certificate, please contact us at telephone: (86-755) 8307 1443, or email: CN.Doccheck@sgs.com Page No.: 22 of 26



Section 2: Photos of Company

2.1 Photos of Company and Product Sample

Description: Company Gate	Description: Office
Made-in-China.com	Made-in-China.com
Description: Workshop	Description: Workshop



This document is issued by the Company under its General Conditions of Service accessible at <http://www.sgs.com/en/Terms-and-Conditions.aspx>. Attention is drawn to the limitation of liability, indemnification and jurisdiction issues defined therein. Any holder of this document is advised that information contained hereon is solely limited to visual examination of the safely and readily accessible portions of the consignment and reflects the Company's findings at the time of its intervention only and within the limits of Client's instructions, if any. The Company's sole responsibility is to its Client and this document does not exonerate parties to a transaction from exercising all their rights and obligations under the transaction documents. Any unauthorized alteration, forgery or falsification of the content or appearance of this document is unlawful and offenders may be prosecuted to the fullest extent of the law.

Attention: To check the authenticity of testing / inspection report & certificate, please contact us at telephone: (86-755) 8307 1443, or email: CN.Doccheck@sgs.com **Page No.: 23 of 26**



<p>Made-in-China.com</p>	<p>Made-in-China.com</p>
<p>Description: Warehouse</p>	<p>Description: Showroom</p>
<p>Made-in-China.com</p>	<p>Made-in-China.com</p>
<p>Description:</p>	<p>Description:</p>
<p>Made-in-China.com</p>	<p>Made-in-China.com</p>
<p>Description:</p>	<p>Description:</p>



This document is issued by the Company under its General Conditions of Service accessible at <http://www.sgs.com/en/Terms-and-Conditions.aspx> Attention is drawn to the limitation of liability, indemnification and jurisdiction issues defined therein. Any holder of this document is advised that information contained hereon is solely limited to visual examination of the safely and readily accessible portions of the consignment and reflects the Company's findings at the time of its intervention only and within the limits of Client's instructions, if any. The Company's sole responsibility is to its Client and this document does not exonerate parties to a transaction from exercising all their rights and obligations under the transaction documents. Any unauthorized alteration, forgery or falsification of the content or appearance of this document is unlawful and offenders may be prosecuted to the fullest extent of the law.

Attention: To check the authenticity of testing / inspection report & certificate, please contact us at telephone: (86-755) 8307 1443, or email: CN.Doccheck@sgs.com **Page No.: 24 of 26**



<p><i>Made-in-China.com</i></p>	<p><i>Made-in-China.com</i></p>
<p>Description:</p>	<p>Description:</p>
<p><i>Made-in-China.com</i></p>	<p><i>Made-in-China.com</i></p>
<p>Description:</p>	<p>Description:</p>
<p><i>Made-in-China.com</i></p>	<p><i>Made-in-China.com</i></p>
<p>Description:</p>	<p>Description:</p>



This document is issued by the Company under its General Conditions of Service accessible at <http://www.sgs.com/en/Terms-and-Conditions.aspx> Attention is drawn to the limitation of liability, indemnification and jurisdiction issues defined therein. Any holder of this document is advised that information contained hereon is solely limited to visual examination of the safely and readily accessible portions of the consignment and reflects the Company's findings at the time of its intervention only and within the limits of Client's instructions, if any. The Company's sole responsibility is to its Client and this document does not exonerate parties to a transaction from exercising all their rights and obligations under the transaction documents. Any unauthorized alteration, forgery or falsification of the content or appearance of this document is unlawful and offenders may be prosecuted to the fullest extent of the law.

Attention: To check the authenticity of testing / inspection report & certificate, please contact us at telephone: (86-755) 8307 1443, or email: CN.Doccheck@sgs.com **Page No.: 25 of 26**



<p><i>Made-in-China.com</i></p>	<p><i>Made-in-China.com</i></p>
<p>Description:</p>	<p>Description:</p>
<p><i>Made-in-China.com</i></p>	<p><i>Made-in-China.com</i></p>

-- End of the Report --



This document is issued by the Company under its General Conditions of Service accessible at <http://www.sgs.com/en/Terms-and-Conditions.aspx>. Attention is drawn to the limitation of liability, indemnification and jurisdiction issues defined therein. Any holder of this document is advised that information contained hereon is solely limited to visual examination of the safely and readily accessible portions of the consignment and reflects the Company's findings at the time of its intervention only and within the limits of Client's instructions, if any. The Company's sole responsibility is to its Client and this document does not exonerate parties to a transaction from exercising all their rights and obligations under the transaction documents. Any unauthorized alteration, forgery or falsification of the content or appearance of this document is unlawful and offenders may be prosecuted to the fullest extent of the law.

Attention: To check the authenticity of testing / inspection report & certificate, please contact us at telephone: (86-755) 8307 1443, or email: CN.Doccheck@sgs.com